

COMPETENCE B 2190

Built-In Single Oven

Operating Instructions



Dear Customer,

Please read these operating instructions through carefully.
Above all, please take note of the "Safety" section on the first few pages. Please keep these operating instructions for future reference. Pass them on to any subsequent owner of the appliance.



The warning triangle and/or specific words (**Warning!**, **Caution!**, **Important!**) are used to highlight instructions that are important for your safety or for the function of the appliance. It is imperative that these instructions are observed.



1. This symbol guides you step by step when operating the appliance.

2. ...

3. ...



Next to this symbol you receive additional information and practical tips on using the appliance.



Tips and information about the economical and ecological use of the machine are marked with a cloverleaf.

Before calling out an engineer to a fault please read the chapter „What to do if...“ as you may be able to resolve the problem yourself.

For further assistance contact your local AEG Service Force Centre, see the chapter „Service and Spare Parts“.

Printed on paper manufactured with environmentally sound processes.
He who thinks ecologically acts accordingly ...

CONTENTS

Operating Instructions	5
Safety Instructions	5
Disposal	7
Description of the Appliance	8
Control panel	8
Oven Features	9
Oven accessories	10
Oven Functions	11
Before using for the first time	12
Setting/Changing the Time	12
Cleaning for the first time	13
Operating the Oven	14
Inserting the Shelf and Universal Sheet	14
Attaching/removing the grill pan handle	15
Switching the Oven On and Off	16
Using the Automatic Function	17
Automatic Switching Off	17
Automatic Switching On and Off	18
Checking Automatic Programme Settings	18
Changing Automatic Programme Settings	18
Cancelling an Automatic Programme	19
Information on the Automatic Function	19
Countdown	20
Changing the Signal Tone	20
Usage, Tables and Tips	21
Baking	21
Baking Tables	23
Table: Desserts	25
Roasting	26
Table: Meat, roasting, casseroles	27
Table: Roasting, casseroles, au gratin	29

Grilling	31
Grilling Table	32
Defrosting	33
Defrosting table	33
Cleaning and Care	34
The Exterior of the Appliance	34
Oven Interior	34
Accessories	34
Side Rails	35
Grill Element	36
Oven Light	37
Oven Door	38
Oven Door Glass	39
What to do if	40
Service and Spare Parts	41
Customer Service	42
Guarantee Conditions	43
Special accessories	44
Installation Instructions	45
Technical Data	45
Regulations, Standards, Directives	45
Safety Instructions for the Installer	46
Assembly	47
Electrical Connection	54

OPERATING INSTRUCTIONS



Safety Instructions

The new appliance may only be assembled and connected by **an approved installer**.

Please observe this instruction, otherwise the warranty will not cover any damage that may occur.

The safety features of AEG electrical appliances comply with accepted technical standards and the German Appliance Safety Law. However, we also consider it our obligation as a manufacturer to make you aware of the following safety information.

General Safety

- When using other electrical appliances ensure the cable does not come into contact with the hot surfaces of the oven.
- Do not store flammable substances in the oven. They could ignite when the oven is switched on.
- For safety reasons do not clean the appliance with a steam or high pressure cleaner.
- If force is used, above all on the edges of the front pane of glass, the glass may break.
- When cooking, roasting and grilling the oven door will become hot. **Therefore always keep small children away from the door.**
- Overheated fat and oil can catch fire quickly. Please always stay close to the appliance when preparing food in fat or oil (e.g. chips).
- **Repairs** to the appliance may **only be performed by** qualified service engineers. Improper repairs can give rise to significant hazards. If your appliance needs repairing, please contact your local AEG Service Force Centre.
- In the case of the appliance malfunctioning: remove the fuses or switch off the circuit breaker.

Intended Use

- This appliance must not be used for purposes other than that intended, it must only be used for the cooking, roasting and baking of food in the home.
- Only use the appliance to prepare food.
- Do not use the oven to heat the room.

In this way you avoid damaging your appliance

- Do not line your oven with aluminium foil and do not place a baking sheet or dish on the oven floor, otherwise the oven enamel will be damaged by the resulting build up of heat.
- Clean the appliance after each use. Spills are then easier to clean up and do not become burnt onto the surface.
- Any drops of fruit juice that fall from the baking sheet will leave spots that cannot be removed. Use the universal sheet for very moist cakes.
- Never pour water directly into the hot oven. The enamel may be damaged.
- Do not sit on the open oven door.
- Do not store moist food in the oven.

Eco-Insulation

In the factory the oven is fitted with eco-insulation. This insulation has been tested for pollutants by independent test institutes and categorised as harmless



Disposal

Disposing of the packaging materials

All materials used can be fully recycled.

The plastics are marked as follows:

- >PE< for polyethylene, e.g. as used for the outer wrapping and the bags inside.
- >PS< for polystyrene foam, e.g. as used for the packing pieces, completely free of CFCs.

The cardboard is made from 80% recycled paper.

Disposal of old appliances

All old appliances must be correctly disposed of for environmental reasons.



Warning! When disposing of an old appliance, make it unusable by cutting off the cable. Remove any door catches to prevent small children being trapped inside.



Information on disposal

- The appliance must not be disposed of in the household rubbish.
- You can obtain information about collection dates or public tips from your local refuse department or council.

Description of the Appliance

Control panel

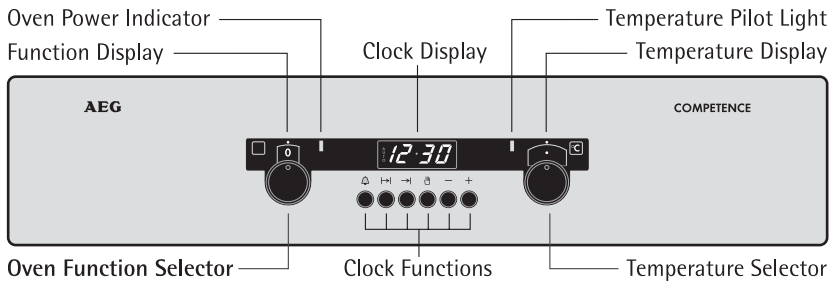

Oven Function Selector and Function Display

Retractable rotary knob, used for selecting the required oven function. The oven function selected is indicated in the oven function display.

Temperature Selector and Temperature Display

Retractable rotary knob, used for selecting the required oven temperature. The oven temperature selected is indicated in the temperature display.

Clock Functions and Time Display

Buttons for setting the clock functions. The current time or the time set on the interval countdown is displayed.

Oven Power Indicator

The oven power indicator illuminates as soon as the oven is switched on.

Temperature Pilot Light

The temperature pilot light illuminates while the oven is heating up and extinguishes when the selected temperature is reached. It then cycles on and off during cooking to show that the temperature is being maintained.

Oven Features

Shelf Positions

There are side rails on both sides of the oven, each of these has 6 shelf positions.

Please note that the shelf positions are counted **from top to bottom**.

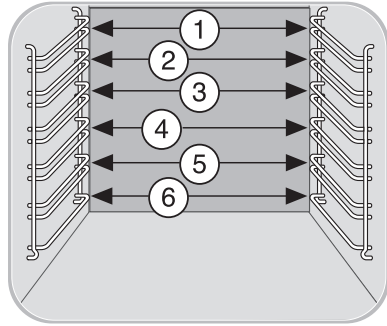

Anti-Tip Device

All slide-in parts are fitted with an anti-tip device to prevent them being unintentionally pulled all the way out.

When inserting slide-in parts, the anti-tip device must be at the rear.

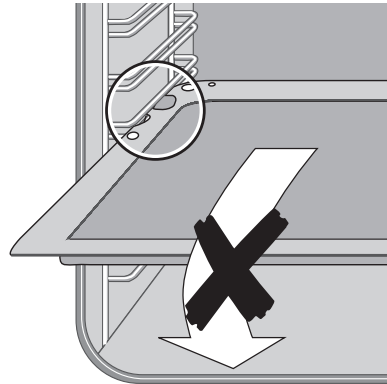

Fat Filter

The fat filter supplied with your appliance protects the fan in the rear wall of the oven from soiling.

Always use the filter when **roasting** uncovered food or using hot air or Rotitherm.

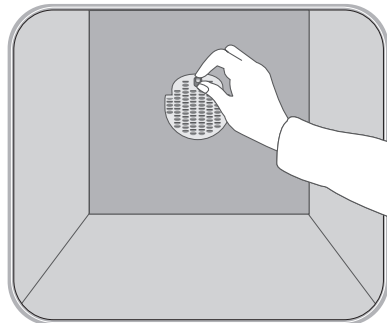

Oven accessories

The oven is provided with the following accessories:

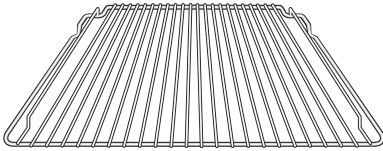

Wire shelf

For ovenware, cake tins, roasts and grilled items

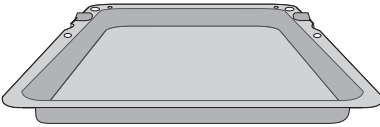

Universal sheet

For moist cakes, juicy roasts or as a baking sheet or collecting vessel for fat

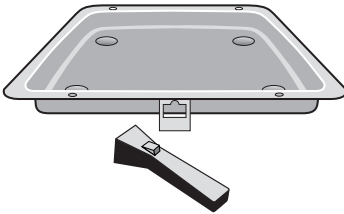

Grill pan with handle

Support for the grill tray as a collecting vessel for fat

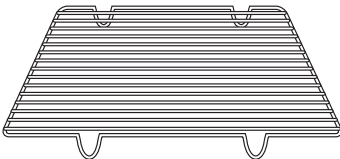

Grill pan tray

Insert for the grill pan for grilling smaller amounts of grilled food

Oven Functions

The following functions are available for the oven:

Fan Cooking

Fan cooking is particularly suited to **baking** on **several levels** at the same time.

Oven temperatures are generally 20-40 °C lower than for conventional heat.

A ring heater and part of the bottom element are used.

In addition a fan in the rear wall of the oven ensures that the hot air in the oven is circulated continuously. The food is heated from all sides.

Rotitherm

Rotitherm is particularly suited to **grilling** or **roasting** larger pieces of meat or game on one level. This function is also suitable for '**au gratin**' dishes and **browning**.

The grill element and fan are used simultaneously.

Grill

Grilling is particularly suited to the **grilling** or **toasting** of flat foods, for example, steaks, cutlets, fish or toast.

The heat is provided by the grill element on the roof of the oven.

Defrosting

The oven's defrosting function allows you to evenly **start to defrost** or to **defrost**. It is particularly suitable for delicate foods, for example, flans, butter ice cream, bread, fruit.

With this function, the fan is in operation without heat.

Before using for the first time



Setting/Changing the Time



The time display will flash after the electrical supply is connected.

You must then first set the time.

If the time has not been set, the oven cannot be switched on.

Setting the Time

1. Press the  button.
2. Set the current time within 5 seconds using the  or  buttons.
The time appears in the display.
The oven is now ready for use.

-  By pressing the  or  button for more than 2 seconds, the minutes will start to run forwards or backwards until the button is released again. By this means you can reach the required setting quicker.

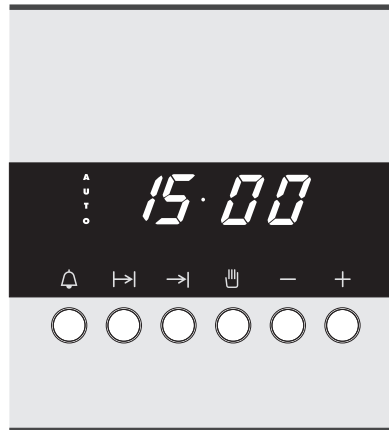



-  If the appliance has been isolated from the mains, e.g. due to a power failure, the time display will flash again. In this case reset the time again, as described above.

Changing the Time

If you wish to correct the time, e.g. on the change over from summer to winter time, repeat the process described under "Setting the Time".

Cleaning for the first time

Before you use the oven for the first time, you should clean it thoroughly. You can switch on the oven light to make cleaning easier.

-  1. Turn the oven function control knob to oven lighting .
2. Remove all accessories and the side rails and wash with warm water and washing up liquid.
3. Also wash out the oven with warm water and washing up liquid, and dry.
4. Clean the front of the appliance with a damp cloth.



Tip: Use commercially available cleaner for stainless steel fronts that at the same time also form a protective film against finger marks.



Important: Do not use any caustic or abrasive cleaners! The surface could be damaged.

Operating the Oven

Inserting the Shelf and Universal Sheet

All slide-in parts have a small protrusion on the right and left. This protrusion is an anti-tip device and must point downwards.

Inserting a Shelf

- ➡ Insert the **shelf** such that the two guide rails point upwards. The anti-tip device must point downwards and be in the rear of the oven.

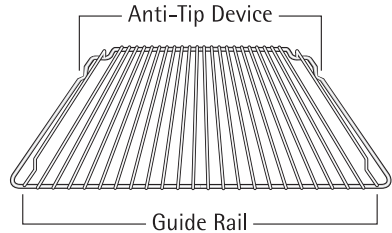

Inserting the Shelf and Sheet

- ➡ When the **shelf and universal sheet** are used together, carefully place the shelf anti-tip device in the protuberances on the sheet.

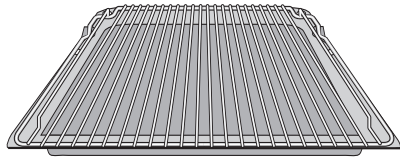

Attaching/removing the grill pan handle

The handle is particularly useful for easy removal of the grill pan and tray out of the hot oven.

Attaching the handle

-  Insert the **handle** at an angle from above into the recesses on the grill pan (1), raise it slightly then lower it (2), until it engages audibly.



Caution: There is a risk of burns!

Important: Check that the handle is securely attached!

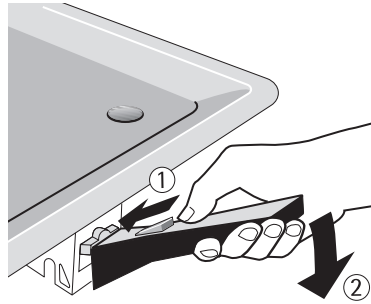

Removing the handle

-  Press the release button on the top of the handle (1) and lift up the handle (2) to remove it.



Important: Never leave the handle in the heated oven! Overheating can cause the handle to deform or break.

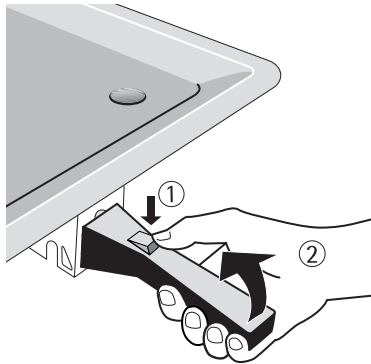

Switching the Oven On and Off

-  **1.** To use, press the “Oven Functions” and “Temperature Selector” knobs to release them.
The control knobs then protrude.
- 2.** Set the required function by turning the “Oven Function” control knob.
The functions display indicates the symbol for the function selected.
- 3.** Set the required temperature by turning the “Temperature Selector”.
The temperature display indicates the temperature selected.

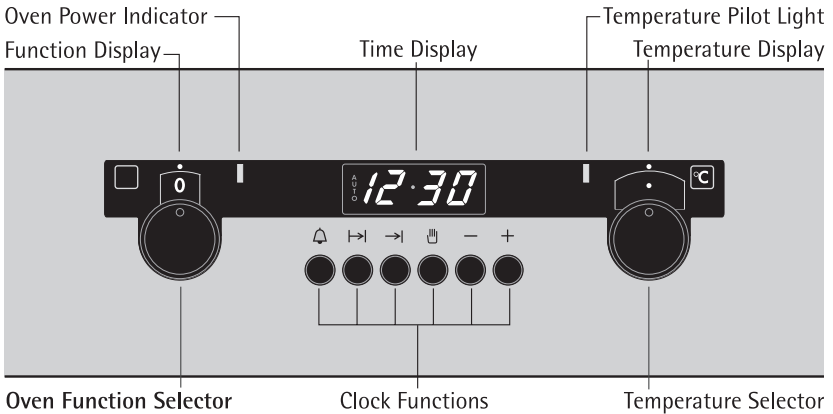

The oven power indicator illuminates as long as the oven is in operation.

The temperature pilot light illuminates whilst the oven is heating up. When the temperature set is reached, the temperature pilot light extinguishes. It will then cycle on and off to show that the temperature is being maintained.

- 4.** To switch the oven off, turn the “Oven Function Selector” and the “Temperature Selector” to the off position.
- 5.** Retract the control knobs by pressing them.

Using the Automatic Function



There are two ways of using the automatic function:

- **Automatic Switch Off:** When you have the oven switched on and simply do not want to forget to switch it off at the right time, you can use the clock to set either the **duration** or the **end** of the cooking time. The oven then switches itself off automatically.
 - **Automatic Switching On and Off:** When, for example, in the morning or at lunch time you want to prepare a dish for the evening, you can set the **duration** and also the **end** of the cooking time. The oven then switches on automatically at the calculated start time, and switches off again automatically at the end of cooking.
- **Example:** The roast requires cooking for 1 hour: COOK TIME = 1.00.
The roast should be ready at 18:00: END TIME = 18.00.

The oven function can be selected either before or after setting the automatic function.



Automatic Switching Off

1. Select the required oven function.
2. Select the required temperature.
3. Press the "COOK TIME"  button.

4. Set the required cooking time within 5 seconds using the  and  buttons.









The "AUTO" symbol illuminates and indicates that the oven is set up in automatic mode.

As soon as the cooking time is at an end, the oven switches off automatically. The "AUTO" symbol flashes and an acoustic signal sounds for approx. two minutes.



5. Press the "COOK TIME"  button to switch off the signal.
6. Press the "MANUAL"  button.
The "AUTO" symbol extinguishes. The oven is now set again to manual mode.
7. **To switch off the oven, turn the oven function and temperature selectors to the off position.**

Automatic Switching On and Off

For automatic switching on and off both the duration and the end of the cooking time must be entered.





-  **1.** Select the required oven function.
- 2.** Select the required temperature.
- 3.** Press the "COOK TIME"  button and, using the  and  buttons, within 5 seconds set the required cooking time.
- 4.** Press the "END TIME"  button and using the  and  buttons, within 5 seconds set the time when you want the meal to be ready. Once the entries have been made, the current time is again shown in the display. The "AUTO" symbol illuminates and indicates that the oven is set up in automatic mode.
The oven switches on automatically at the calculated start time. When the cooking time is at an end, the oven switches off automatically. The "AUTO" symbol flashes and an acoustic signal sounds for approx. two minutes.
- 5.** Press the "COOK TIME"  button to switch off the signal.
- 6.** Press the "MANUAL"  button.
The "AUTO" symbol extinguishes. The oven is now set again to manual mode.
- 7. To switch off the oven, turn the oven function and temperature selectors to the off position.**

Checking Automatic Programme Settings

-  Press the "COOK TIME"  or "END TIME"  button.
The duration or the end of the cooking time set is displayed respectively.

Changing Automatic Programme Settings

You can still change the duration or the end of the cooking time during cooking.

-  **1.** Using the "COOK TIME"  button call up the cooking time, or using the "END TIME"  button, the end of the cooking time.
- 2.** Within 5 seconds press the  or  button until the cooking time or the end of the cooking time is set to the new time you require.

Cancelling an Automatic Programme

1. Using the "COOK TIME"  button call up the cooking time again.
2. Within 5 seconds set all entries to "0" using the  button.
3. Turn the oven function selector and the temperature selector to the off position.







Information on the Automatic Function

The maximum COOK TIME that can be set is 10 hours.

Countdown



The countdown operates independently and can therefore be set when the oven is switched on as well as switched off.

Setting the Countdown

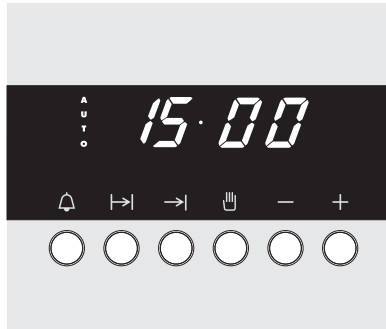

1. Press the "CLOCK"  button.
2. Set the time required within 5 seconds using the  and  buttons.
When the time set on the countdown has expired, an acoustic signal sounds for approx. two minutes.
3. Press the "CLOCK"  button to switch off the signal.



Changing the Setting on the Countdown

1. Using the "CLOCK"  button, re-select the time set on the countdown.
2. Set the new time required within 5 seconds using the  or  buttons.

Switching Off the Countdown Early

1. Using the "CLOCK"  button, re-select the time set on the countdown.
2. Within 5 seconds set the time required to "0" using the  button.



Checking the Countdown Setting

A few seconds after the countdown has been set, the time display indicates the current time again. You can check the amount of time left on the countdown at any time.

1. Using the "CLOCK"  button, re-select the time set on the countdown. The time remaining on the countdown is displayed.

Changing the Signal Tone

The frequency of the signal tone can be set to 3 different tones.

1. Press the  button until the changed signal tone sounds and release. The frequency is set to the next level.
2. Press the  button again until the changed signal tone sounds and release. The frequency is set to the next level.

Usage, Tables and Tips

Baking

Use the fan cooking  oven function for baking.



Important! Do not use a fat filter when baking!

Cake Tins

- Light tins are suitable for fan cooking .

Shelf Positions

- You can bake on up to 3 levels simultaneously using fan cooking .

1 Baking Sheet:
Shelf Position 3

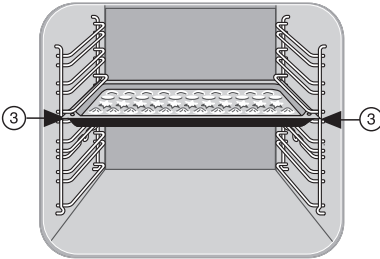

1 Cake Tin:
Shelf Position 5

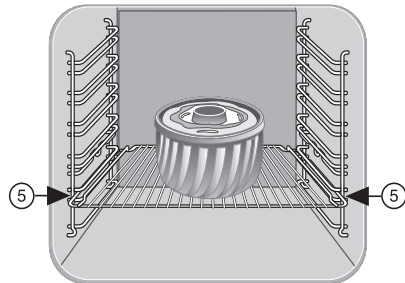

2 Baking Sheets:
Shelf Positions 2 and 5

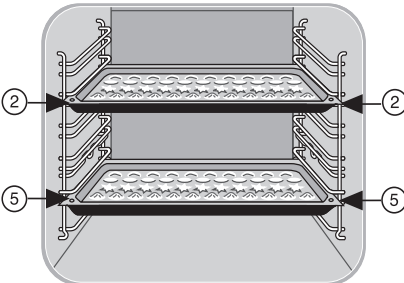

3 Baking Sheets:
Shelf Positions 1, 3 and 5

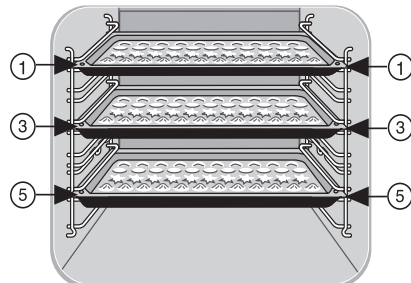

General information

- Please note that the shelf positions are counted from top to bottom.
- Always place cakes in cake tins in the middle of the shelf.

Notes on the Baking Tables

In the tables you will find information on temperatures, cooking times and shelf positions for a selection of recipes.

- Ranges are given for the temperature and cooking time since these are dependent on the mixture, quantity and cake tin used.
- When baking several cakes on baking sheets or in cake tins, the cooking time can be 10-15 minutes longer.
- Moist items (e.g. pizzas & baking, fruit cakes, etc.) should be cooked on a maximum of two levels.
- When using for the first time, we recommend setting the lower temperature. If increased browning is required or the cooking time is too long, select a higher temperature.
- If you cannot find any specific information for one of your own recipes, use information on a similar recipe for guidance.
- Variations in the height of the item to be baked can lead to different degrees of browning at the start of baking. In this case, **please do not change the temperature setting**. Variations in the amount of browning will even themselves out during baking.



Switch off the oven 10-15 minutes before the end of the cooking time to make use of the residual heat.

Unless otherwise stated the information in the tables applies to a cold oven.

Baking Tables

Cakes, Biscuits, Bread, Pies	Fan Cooking 		Time hr. : min.
	Shelf- position from top	Tempera- tur °C	
Using cake tins			
Cakes in Pound Cake tins	5	160-170	1:00-1:10
Sandcakes/Cakes in loaf tins	5	150-160	1:15-1:30
Madeira cake	5	150-160	1:00-1:10
Dundee cake	5	130-140	2:30-3:00
Large Christmas cake (10")	5	130	4:30-5:00
Victoria Sandwich	2 + 5	160	0:25-0:35
Pastry cases	2 + 5	170-190	0:10-0:25
Bakewell tart	4	160-170	0:45-0:55
Swiss roll	-	-	0:10-0:15
Flans & quiches	3 or 4	170-180	0:30-0:50
Using baking sheets			
Short bread	2 + 5	140-150	0:40-0:50
Biscuits	2 + 5	150-170	0:15-0:25
Macaroons	2 + 5	140-150	0:25-0:35
Apple strudel	4	170-180 ¹	0:30-0:50
Choux pastry buns	2 + 5	160-170 ¹	0:20-0:35
Buns / cup cakes	2 + 5	150-160 ¹	0:25-0:35
Scones	2 + 5	190-200 ¹	0:10-0:15
Meringues	3	75	3:30-4:30
Sausage rolls	2 + 5	170-180 ¹	0:20-0:35
Pizza	4	180-200	0:30-0:50

Cakes, Biscuits, Bread, Pies	Fan Cooking 		Time hr. : min.
	Shelf- position from top	Tempera- tur °C	
Bread			
Wholemeal bread	4	180-200 ¹	0:40-0:45
White bread	4	180-200 ¹	0:40-0:45

1) Pre-Heat oven.

Select the lower temperature to start with, then select the higher one only if required.

Tips on Baking

	Tip
This is how to tell if your cake is cooked through	Push a wooden skewer into the highest point of the cake. When no more cake mixture sticks to the wood, you can switch off the oven and utilise the residual heat.
The cake collapses (is sticky, not properly cooked through, water marks)	Check your recipe. Next time use less liquid. Observe mixing times, particularly when using kitchen appliances.
The cake is too light	Next time select a dark cake tin or place the cake one level lower.
Cake with moist topping/ cake is not cooked through, is unevenly browned	Next time bake at a lower temperature and increase the cooking time.

Table: Desserts

Desserts	Fan Cooking 		Time Hr. : Min.
	Shelf position from top	Tempera- ture °C	
Apple pie	4	180-190	0:45-0:50
Rice pudding	4	130-140	2:00-2:30
Fruit crumble	4	160	0:50-1:10
Pineapple upside down cake	4	160	0:35-0:45
Pavlova	4	130	1:00-1:10
Baked custard	4	150-160	0:45-1:00
Baked apples	4	160-170	0:40-1:00
Bread and butter pudding	4	170-180	0:40-0:55
Apple charlotte	4	180-190	0:40-0:55
Soufflé - sweet/savoury	4	170-190 ¹	0:30-0:45

1)Pre-Heat oven.

The figures printed bold indicate the **best oven function and temperature** to use in each case.

Select the lower temperature to start with, then select the higher one only if required.

Roasting

For roasting, use the fan cooking  or rotitherm  oven function.



Important: Use the fat filter when roasting!

Roasting Dishes



- Any heat-resistant dish is suitable for roasting.
- If the dish has plastic handles, ensure that the handles are heat-resistant.
- Large roasts can be roasted **directly on the meat tin or on the shelf with the meat tin underneath** (e.g. turkey, goose, 3-4 chickens, 3-4 knuckles).
- When roasting meat choose a dish which is just a little larger than the joint itself to retain the juices in a small area thus preventing fat from spitting and soiling the oven.
- We recommend roasting all lean types of meat **in a casserole with a lid** (e.g. veal, pork or beef pot roasts, frozen meat). This way the meat will remain moist.
- You can roast all types of meat that should have a crispy exterior **in a casserole without a lid** (e.g. pork, meat loaf, lamb, duck, 1-2 knuckles, 1-2 chickens, small poultry, sirloin, fillet, game).
- **Tip:** If you use dishes for roasting (particularly for small amounts), the oven will not get so dirty!

Shelf Positions

- Please see the following table for the shelf positions to use.

Notes on the Roasting Tables



Information is given in the table on suitable oven functions, temperature settings, cooking times and shelf positions for various types of meat. The cooking times are only for guidance.



- We recommend roasting meat and fish **in the oven from a weight of 1 kg**.
- The cooking time required is dependent on the type and quality of the meat.
- If you are just roasting meat without cooking any other type of food in the oven at the same time we recommend the rotitherm  oven function.
- If you wish to roast meat and cook other dishes at the same time, use the fan cooking  function.
- To stop juices that exude from the meat burning onto dishes, we recommend adding a little liquid in the roasting dish.
- Turn the roast after approx. 2/3 of the cooking time.



Switch off the oven 10-15 minutes before the end of the cooking time to make use of the residual heat.

Table: Meat, roasting, casseroles

Meat	Fan Cooking 		Rotitherm 		Time hrs. : min.
	Shelf position from Top	Temperature °C	Shelf Position from Top	Temperature ² °C	
Pork					
Shoulder; leg; rolled; boned spare rib; loin of pork	4	170-180	4	150-160	0:30-0:35 per 450 g/1 lb plus 30-35 mins
Beef					
Inexpensive cuts	4	160-170	-	-	0:35-0:40 per 450 g/1 lb plus 15-20 mins
Prime cuts					
-rare	4	170-180¹	3 or 4	150-160¹	0:15-0:20 per 450 g/1 lb plus 15-20 mins

Meat	Fan Cooking 		Rotitherm 		Time hrs. : min.
	Shelf position from Top	Temperature °C	Shelf Position from Top	Temperature ² °C	
-medium	4	170-180	3 or 4	150-160	0:20-0:25 per 450 g/1 lb plus 25-25 mins
-well done	4	170-180	4	150-160	0:30-0:35 per 450 g/1 lb plus 25-30 mins
Yorkshire pudding					
- small	3	200 ¹	3	250	0:10-0:15
- large	4	180-190 ¹	4	220-230	0:30-0:40
Lamb	4	170-180	4	150-160	0:30-0:35 per 450 g/1 lb plus 30-35 mins
Veal	4	170-180	3 or 4	150-160	0:30-0:35 per 450 g/1 lb plus 30-35 mins



1) Pre-Heat oven.



2)For rotitherm roasting and joints of 5 lb & over eliminate the additional time.

The figures printed bold indicate the **best oven function and temperature** to use in each case.

Select the lower temperature to start with, then select the higher one only if required.

Table: Roasting, casseroles, au gratin

Poultry, Game, Fish, Vegetables	Quantity approx.	Fan Cooking 		Rotitherm ¹ 		Time Hr.: Min.
		Shelf position from Top	Tempe- rature °C	Shelf position from Top	Tempe- rature °C	
Casseroles, miscellaneous						
Casseroles	1 kg/2 lbs	4	150	-	-	2:30-3:00
Lancashire Hot Pot	1 kg/2 lbs	4	150-160	-	-	2:15-2:30
Moussaka	1 kg/2 lbs	4	170-180	-	-	0:40-0:50
Meat Loaf	675 g/ 1.5 lbs	4	170-180	4	160-170	1:00-1:10
Poultry/ Game						
Chicken	1 kg/2 lbs	4	170-180	4	160	0:50-1:10
Chicken	1.5 kg/3 lbs	4	170-180	4	160	1:15-1:30
Duck	1.5-2 kg/ 3.5-4 lbs	4	180-190	4	160	1:15-1:45
Goose	3.5-5 kg/ 8-10 lbs	4 or 5	170-180	4 or 5	130-140	2:30-3:00
Turkey	2.5-3.5 kg 5-7 lbs	4	160	4 or 5	140-150	1:30-2:00
Turkey	4-6 kg/ 8-13 lbs	4 or 5	150-160	4 or 5	130-140	2:30-4:00
Pheasant, Wild Duck, Rabbit	1 kg/2 lbs	3 or 4	210	3 or 4	170-180	0:30-1:00
Partridge/ Pigeon	per 300-500 g	3 or 4	190-200	3 or 4	170-180	0:30-0:50
Fish (baked, steamed)						
Whole fish	1-1.5 kg/ 2-3 lbs	4	160-170	3 or 4	150-160	0:45-1:15
Fish pies, bakes	750 g-1 kg/ 1.5-2 lbs	3 or 4	170-190	3 or 4	160-180	0:30-1:00

Poultry, Game, Fish, Vegeta- bles	Quantity approx.	Fan Cooking 		Rotitherm ¹ 		Time Hr.: Min.
		Shelf posi- tion from top	Tempe- rature °C	Shelf Posi- tion from top	Tempe- rature °C	
Vegetables						
Stuffed pepper/ aubergines		4	180-190	3 or 4	160-180	0:30-1:00
Au gratin dis- hes		3	180-200	3	180-190	0:15-0:45

1) Place food in suitable containers and position wire shelf as per chart.
 The figures printed bold indicate the **best oven function and temperature** to use in each case.
 Select the lower temperature to start with, then select the higher one only if required.

Grilling

Use the grill  oven function with a temperature of 275 °C for grilling.

Important: Always pre-heat the empty oven **for 5 minutes using the grill function**

It is not necessary to use the fat filter.

Ovenware for Grilling

- For small amounts use the grill pan and the grill pan grid together for grilling.
- For larger amounts use the wire shelf and the meat tin together for grilling.



Warning: The **grill pan handle must be removed** whilst grilling!

Always use oven gloves when removing or attaching the grill pan handle.

Shelf Positions

- For grilling flatter foods, always use the **2nd shelf position from the top**.

Notes on the Grilling Table

The grilling times are for guidance only and are dependent on the type and quality of the meat or fish.

- Grilling is particularly suitable for flat pieces of meat and fish.
- Turn over pieces of meat or fish halfway through the grilling time.



Warning: Always grill with the oven door shut.

Grilling Table

Food		Shelf Level from top	Grilling Time minutes each side
Bacon rashers		2.	2-3
Beefburgers		2.	6-10
Chicken joints		2.	10-15
Chops:	lamb pork	2.	7-10 10-15
Fish:	whole trout/hering fillet plaice/cod	2.	8-12 4-6
Kebabs		2.	10-15
Kidneys:	Lamb/pig	2.	4-6
Liver:	Lamb/pig	2.	5-10
Sausages		2.	10-15 (turn as required)
Steaks	rare medium well	2.	3-6 6-8 7-10

Defrosting

To defrost food, use the oven's defrosting function  at 30°C.

Defrosting dishes

- Put the food on a plate and put the plate on the tray.
- Use only parchment paper or film to cover the food. Do not use plates or dishes as they significantly increase the defrosting time.

Shelf levels

- For defrosting, insert the tray in the **4th level from the top**.

Notes on the defrosting table

The table below gives you a few reference points on the defrosting times.

Defrosting table

Meal	Defrosting time Min.	Final defrosting time Min.	Note
Chicken, 1000 g	100-140	20-30	Place the chicken on an upside-down saucer on a large plate. Defrost open and turn after half the time, or defrost covered with film.
Meat, 1000 g	100-140	20-30	Defrost open and turn after half the time or cover with film.
Meat, 500 g	90-120	20-30	Defrost open and turn after half the time or cover with film.
Trout, 150 g	25-35	10-15	Defrost open
Strawberries, 300 g	30-40	10-20	Defrost open
Butter, 250 g	30-40	10-15	Defrost open
Cream, 2 x 200 g	80-100	10-15	Defrost open (Cream can also be whipped well if parts of it are still slightly frozen)
Flan, 1400 g	60	60	Defrost open.

Cleaning and Care

The Exterior of the Appliance

-  Wipe the front of the appliance with a soft cloth and warm water with washing up liquid.
 - Do not use scourers, caustic cleaners or abrasive items.
 - In the case of stainless steel fronts, you may use commercially available stainless steel cleaners. These also provide a protective film against finger marks.

Oven Interior

Oven Lighting

You can switch on the oven light to make cleaning easier.

Cleaning

-  **1.** Wipe the oven clean after each use with water and washing up liquid with a little vinegar added.
- 2.** Then rub the oven dry with a cloth.
- 3.** Remove stubborn marks with special oven cleaner.



Warning: Do not clean the appliance with a steam or high pressure cleaner for safety reasons.

Important: When using oven spray, please ensure that you follow the manufacturer's instructions.

Accessories

-  After each use rinse all slide-in parts (shelf, etc.) and dry well. Soak briefly to make them easier to clean.

Side Rails

The side rails on the left and right hand sides of the oven can be removed for cleaning the side walls.

Removing and Fitting the Side Rails

-  1. Pull the rail away from the oven wall at the base and unhook at the top.
2. To refit, insert the side rail at the top and place against the side of the oven at the base.

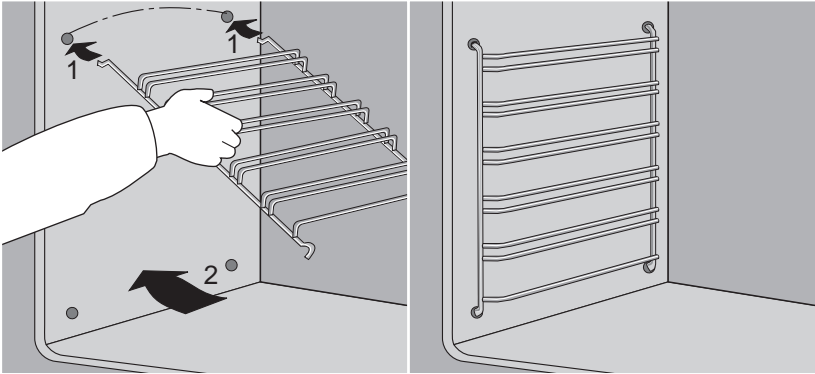

Grill Element

To make the cleaning of the oven roof easier, the grill element can be folded down.



Warning: Only fold down the grill when the oven is switched off and is cold.

Folding Down the Grill Element



Turn the two retaining hooks 90° (a quarter of a turn) towards the middle.

The heater element swings downwards.



Important: Do not use excessive force to lower the heater element. The heater element can break off if excessive force is used.

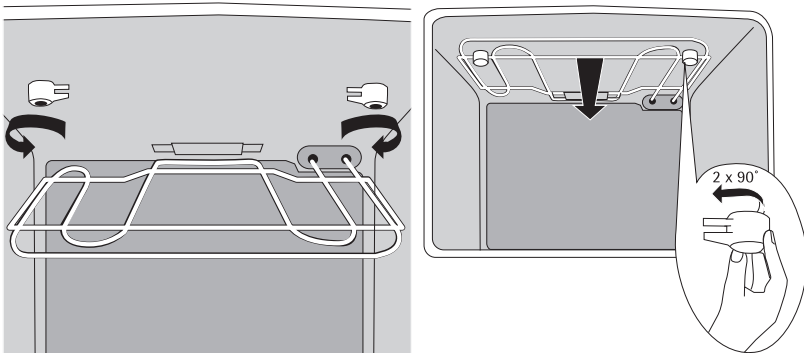

Fitting the Grill Element



Press the heater element gently upwards and turn the retaining hooks 90° towards the rear so that the heater element bracket is between the retaining hooks.



Important: Never slide the retaining hooks onto the heater element. There is a risk of fire.

Oven Light



Warning: There is a risk of electric shock! Before changing the light bulb in the oven:

- Switch off the oven!
- Isolate the oven from the power supply.

Replacing the Light Bulb in the Oven/Cleaning the Glass

1. Place a cloth on the floor of the oven.
2. Remove the glass cover by turning it anti-clockwise and then clean it.
3. **Oven lighting replace with 40 Watt, 230 V, 300 °C heat resistant light bulb.**
4. Refit the glass cover.
5. Remove the cloth from the oven.



Oven Door

The oven door on your appliance can be removed for cleaning.

Removing the Oven Door

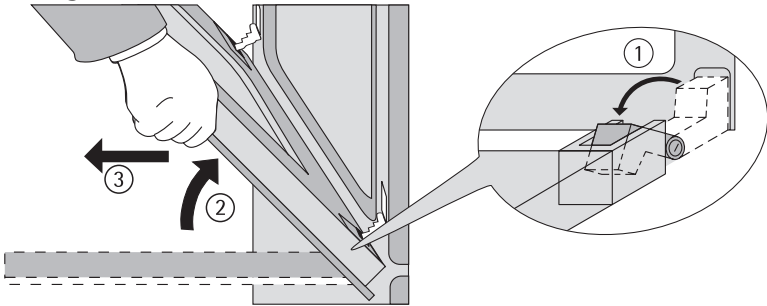

1. Open the oven door completely.
2. **Lift up fully the coloured clamping lever** on both door hinges (1).
3. Close the oven door around 3/4 of the way, **overcoming the resistance** (2).
4. Take hold of the side of the oven door with both hands. Lift the door upwards (Caution: heavy!) and remove from the oven (3).
5. Place the door, with the outer surface downwards, on a soft, flat surface, for example a blanket, to avoid scratches.

Hanging the Oven Door

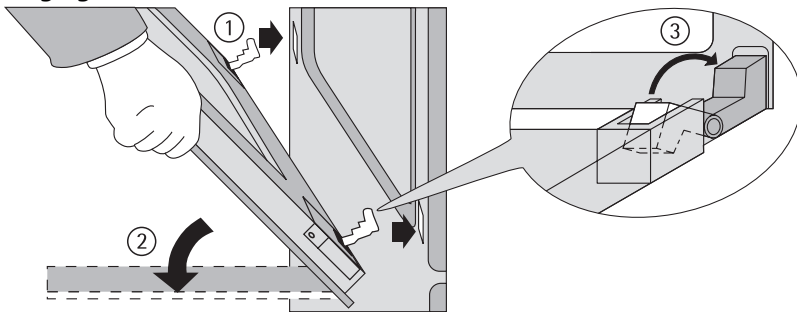

1. Take hold of the sides of the door with both hands from the handle side.
2. Hold the door at an angle of approx. 60°.
3. Slide the door hinges as far as possible into the two cut-outs on the right and left on the bottom of the oven (1).
4. Lift the door up until resistance is met and then open fully (2).
5. Turn the clamping levers on both door hinges back into their original position (3), so that the coloured marks again point upwards.
6. Close the oven door.

Oven Door Glass

The oven door is fitted with two panes of glass, these are fitted one behind the other. The inner pane can be removed for cleaning.



Warning: Please only perform the following steps on the oven door when it has been removed from the oven! When the door is fitted, the reduction in the weight of the door when the glass is removed could lead to the door suddenly closing and creating a hazard.

Removing the Door Inner Glass

1. Remove the oven door and place on a soft, level surface with the handle downwards.
2. Take hold of the pane of glass at the upper edge and slide it against the spring pressure in the direction of the oven door handle until it is free at the base (1).
3. Lift the pane **gently** at the base and remove (2).

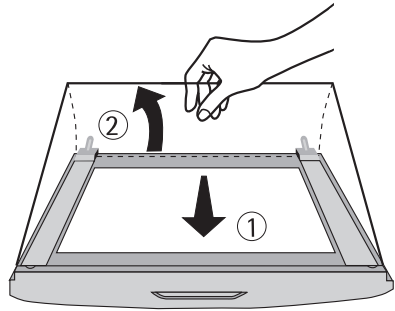

Replacing the Inner Door Glass

1. Guide the pane of glass at an angle from above into the door section on the handle side (1).
2. Lower the pane of glass (2). Place the pane, against the force of the spring on handle side, in front of the retaining section on the lower edge of the door and **slide it under the retaining section**. The pane of glass must sit securely!
3. Refit the oven door.

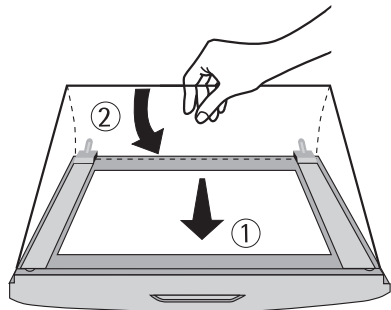

What to do if ...

.... the oven does not heat up?



Check whether

- the appliance is switched on,
- all the necessary settings have been made,
- the mains fuse (fuse box) has blown.

If the fuse blows several times, please call an approved electrician.

.... the oven lighting ceases to function?



Replace the light bulb in the oven (see Cleaning and Care).

If you call in an engineer to resolve a problem listed in these notes, or to rectify an error in the operation of the appliance, the customer service engineer's visit will not be free of charge, even during the warranty period.

If this information does not provide you with the necessary assistance, please seek specialist advice.



Warning: Repairs to the appliance must be carried out by qualified service engineers! Improper repairs can give rise to significant hazards for the user. If your appliance needs repairing, please contact local AEG Service Force Centre.

SERVICE AND SPARE PARTS

In the event of your appliance requiring service, or if you wish to purchase spare parts, contact your local AEG Service Force Centre by telephoning

08705 929 929

Your call will be automatically routed to the Service Centre covering your post code area.

In-guarantee customers should read the section headed 'What to do if...?' have been made, as the engineer will make a charge if the fault is not a mechanical or electrical breakdown.

Please note that proof of purchase is required for in-guarantee service calls.

Help us to help you

Please determine your type of enquiry before writing or telephoning.

When you contact us we need to know,

- Your name,
- Address and post code.
- Telephone number
- Clear and concise details of the fault.
- Name and model of the appliance
- E number (9 digit number found on the rating plate)

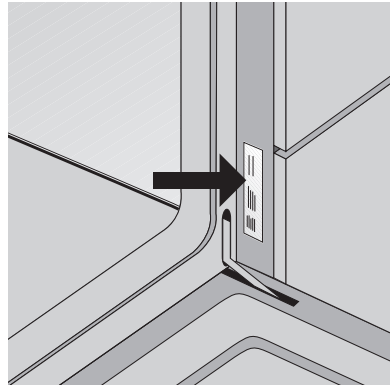

This information can be found on the rating plate in the interior of the appliance at the left.

CUSTOMER SERVICE

For general enquiries or information regarding AEG appliances contact:
Customer Services Department
AEG Domestic Appliances
55-77 High Street
Slough
Berkshire
SL1 1DZ
Tel.: 08705 350 350

GUARANTEE CONDITIONS

Guarantee Conditions

AEG offer the following guarantee to the first purchaser of this appliance.

1. The guarantee is valid for 12 months commencing when the appliance is handed over to the first retail purchaser, which must be verified by purchase invoice or similar documentation.

The guarantee does not cover commercial use.

2. The guarantee covers all parts or components which fail due to faulty workmanship or faulty materials. The guarantee does not cover appliances where defects or poor performance are due to misuse, accidental damage, neglect, faulty installation, unauthorised modification or attempted repair, commercial use or failure to observe requirements and recommendations set out in the instruction book.

This guarantee does not cover such parts as light bulbs, removable glassware, dust bags or filters.

3. Should guarantee repairs be necessary the purchaser must inform the nearest customer service office (manufacturer's service or authorised agent). AEG reserves the right to stipulate the place of the repair (i. e. the customer's home, place of installation or AEG workshop).
4. The guarantee or free replacement includes both labour and materials.
5. Repairs carried out under guarantee do not extend the guarantee period for the appliance. Parts removed during guarantee repairs become the property of AEG.
6. The purchaser's statutory rights are not affected by this guarantee.

European Guarantee

If you should move to another country within Europe then your guarantee moves with you to your new home subject to the following qualifications:

- The guarantee starts from the date you first purchased your product.
- The guarantee is for the same period and to the same extent for labour and parts as exist in the new country of use for this brand or range of products.
- This guarantee relates to you and cannot be transferred to another user.
- Your new home is within the European Community (EC) or European Free Trade Area.
- The product is installed and used in accordance with our instructions and is only used domestically, i. e. a normal household.
- The product is installed taking into account regulations in your new country.

Before you move please contact your nearest Customer Care Centre, listed below, to give them details of your new home. They will then ensure that the local Service Organisation is aware of your move and able to look after you and your appliances.

France	Senlis	+33 (0) 44 62 29 29
Germany	Nürnberg	+49 (0) 911 323 2600
Italy	Pordenone	+39 (0) 1678 47053
Sweden	Stockholm	+46 (0) 8 738 7910
UK	Slough	+44 (0) 1753 219899

Special accessories

The following special accessories for your appliance are available from your specialist dealer:

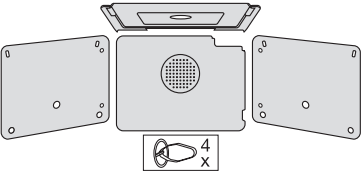
<p>Catalysis set KTU-LT, 4-part E. No. 944 189 024</p> 	
<p>2 side rails, white for white furniture conversion E-Nr. 611 898 700</p>	<p>Stainless steel care agent for all stainless steel appliances E-Nr. 944 190 002</p>

INSTALLATION INSTRUCTIONS



Important: Any electrical installation work must be carried out by a qualified electrician/competent person.

The oven must be installed according to the instructions supplied.

Technical Data

Oven Exterior Dimensions

Height x Width x Depth 60 cm x 56 cm x 55 cm

Oven Interior Dimensions

Height x Width x Depth 31 cm x 39.6 cm x 41 cm

Volume (useable) 51L

Total Rating 230V 2.7Kw
240V 2.9Kw

Regulations, Standards, Directives

This appliance meets the following standards:

- EN 60 335-1 and EN 60 335-2-6
in respect of the safety of electrical appliances for household use and similar purposes and
- DIN 44546 / 44547 / 44548
in respect of the operating features of electric cookers for household use.
- EN 55014-2 / VDE 0875 part 14-2
- EN 55014 / VDE 0875 part 14/12.93
- EN 61000-3-2 / VDE 0838 part 2
- EN 61000-3-3 / VDE 0838 part 3
in respect of the basic protection requirements for electromagnetic compatibility (EMC).



This appliance complies with the following EU directives:

- 73/23/EEG dated 19.02.1973 (Low Voltage Directive)
- 89/336/EEG dated 03.05.1989 (EMC Directive including Directive Amendment 92/31/EEG).



Safety Instructions for the Installer

- In respect of fire protection, this appliance corresponds to type Y (IEC 335-2-6). Only appliances of this type may be installed next to a high cupboard or a wall.
- Contact protection must be guaranteed by the installation.
- The unit in which the appliance is fitted must satisfy the requirements of DIN 68930 in respect of stability.
- This oven must be installed by qualified personnel to the relevant British Standards.
- This oven is heavy. Take care when moving it
- Remove all packaging, both inside and outside the oven before using the oven.
- Do not attempt to modify the oven in any way.

Assembly



Important information

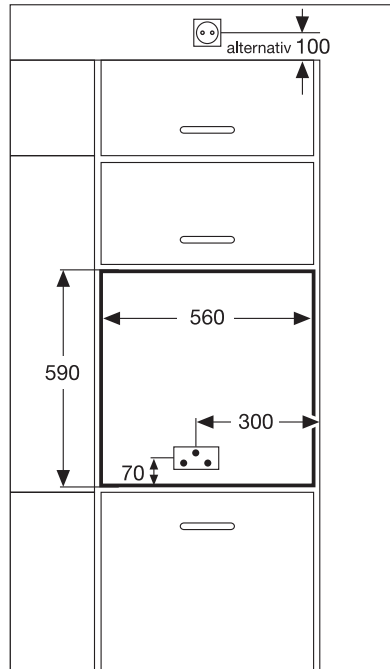
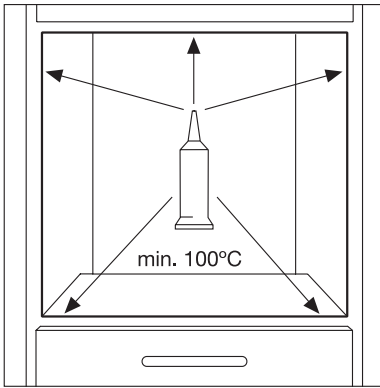

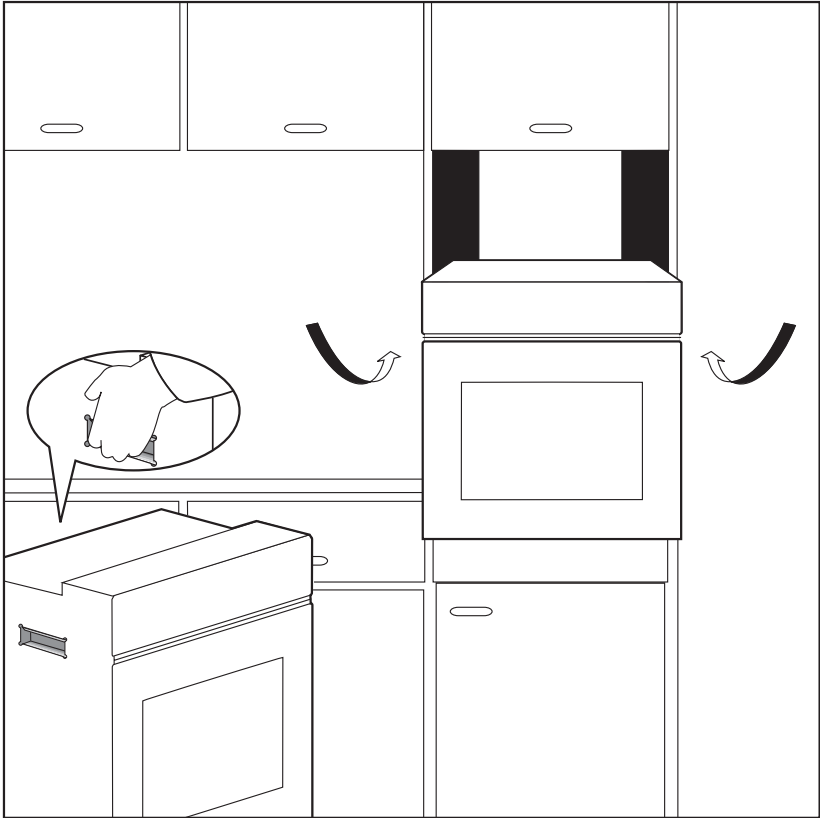

Preparation, kitchen furniture

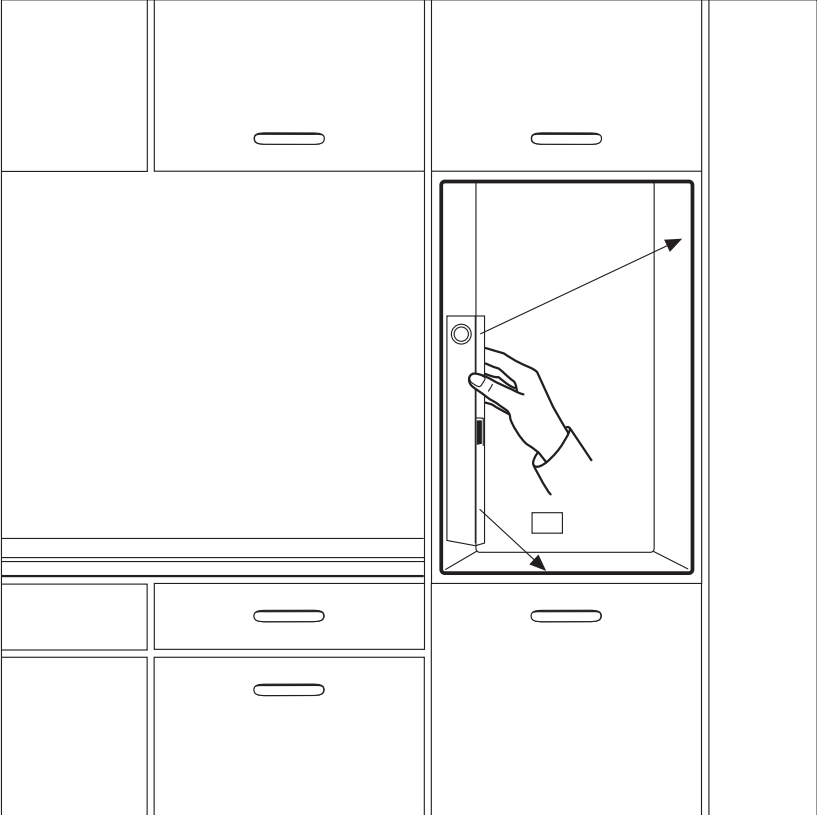

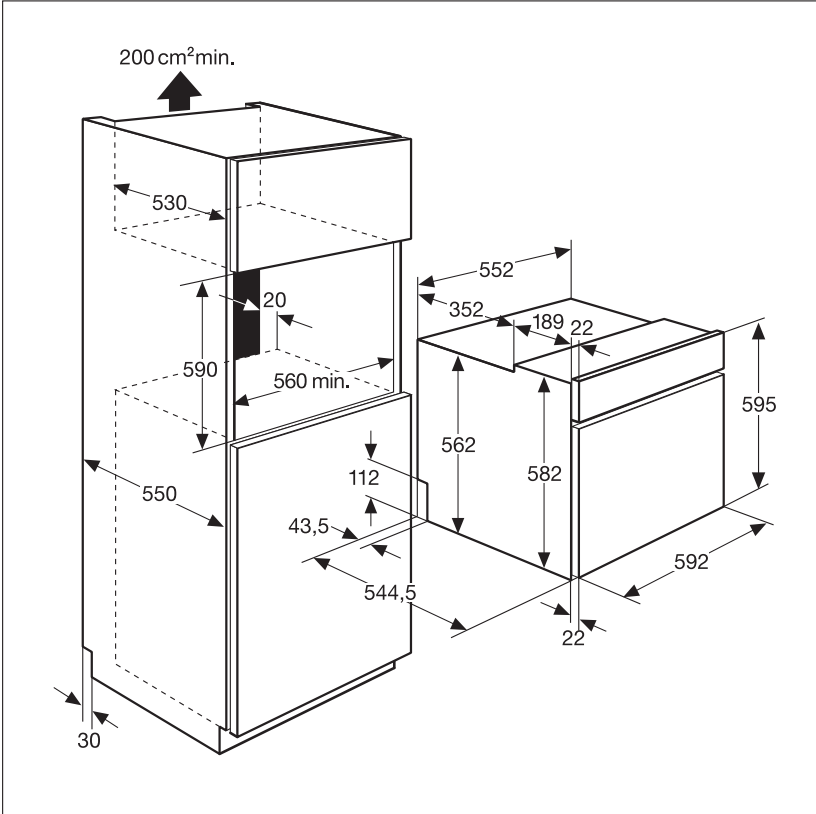

Electrical connection

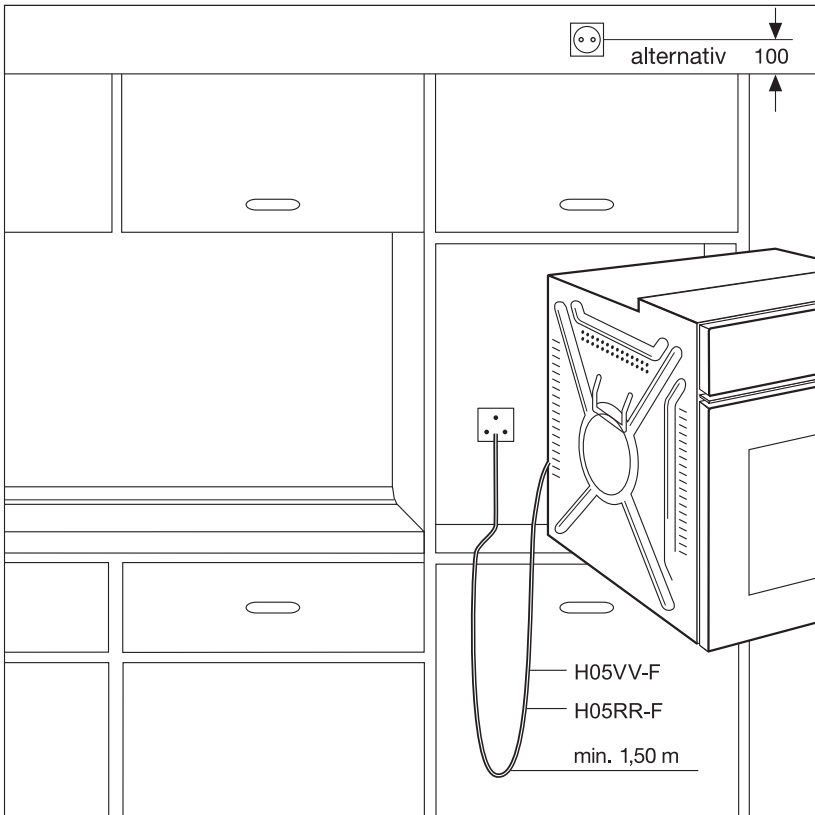
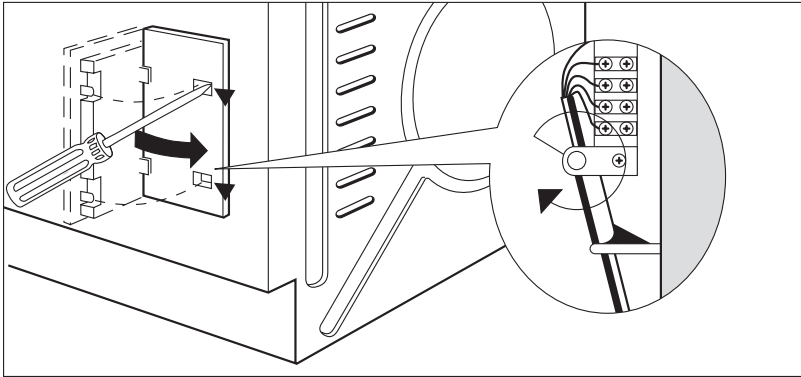

Attachment

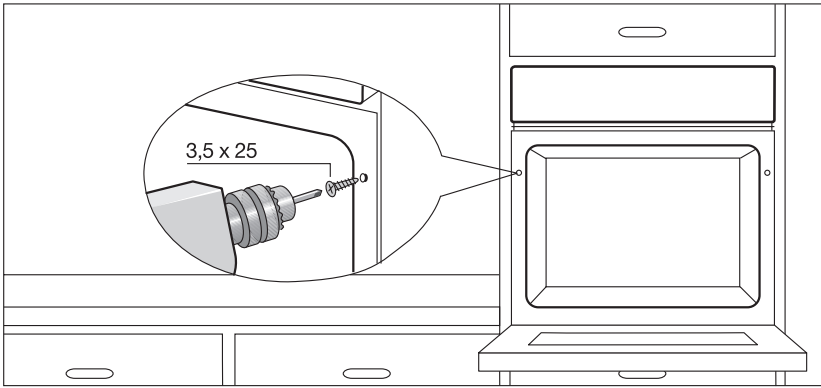

Electrical Connection

The oven is designed to be connected to 230-240V (50Hz) electricity supply

The oven has an easily accessible terminal block which is marked as follows.

- Letter L - Live terminal
- Letter N - Neutral terminal
-  or E - Earth terminal

THIS OVEN MUST BE EARTHED

The cable used to connect the oven to the electrical supply must comply to the specifications given below..

Connection via	Min. size Cable/Flex	Cable/Flex type	Fuse
Cooker control circuit	2.5mm ²	PVC/PVC twin and earth	13A

It is necessary that you install a double pole switch between the oven and the electricity supply (mains), with a minimum gap of 3mm between the switch contacts and of a type suitable for the required load in compliance with the current rules.

The switch must not break the yellow and green earth cable at any point.

Important

After installation and connecting, the cable must be placed so that it cannot at any point reach a temperature of more than 60°C above the ambient temperature.

Before the oven is connected, check that the main fuse and the domestic installation can support the load, and that the power supply is properly earthed.

The manufacturer disclaims any responsibility should these safety measures not be carried out.

AEG Hausgeräte GmbH
Postfach 1036
D-90327 Nürnberg

<http://www.aeg.hausgeraete.de>

© Copyright by AEG

ANC 822 947 163 - 05 - 0899